

**PRODUCT SPECIFICATIONS**

Elkay Soft Sides® Single ADA Fountain Non-Filtered Non-Refrigerated Stainless. Furnished with Flexi-Guard® Safety Bubbler. Mechanical Front Bubbler Button activation. Product shall be Wall Mount (On Wall), for Indoor + Outdoor applications, serving 1 station(s).

<b>Finish:</b>	Stainless Steel
<b>Power:</b>	No Electrical Required
<b>Bubbler Style:</b>	Flexi-Guard® Safety Bubbler
<b>Activation by:</b>	Mechanical Front Bubbler Button
<b>Mounting Type:</b>	Wall Mount (On Wall)
<b>Chilling Capacity:</b>	Non-refrigerated
<b>Dimensions (L x W x H):</b>	12-1/8" x 18-3/4" x 6-1/2"
<b>Approx. Shipping Weight:</b>	16 lbs.
<b>Installation Location:</b>	Indoor + Outdoor
<b>No. of Stations Served:</b>	1

\*\*When used in non-temperature controlled environments, unit(s) must be adequately winterized and/or protected from extreme heat to prevent damage where climates dictate.

- Mechanically-Activated bubbler continues to supply water in event of service disruptions.



**Included with Product:** Fountain  
**Ships in one box.**

AMERICAN PRIDE. A LIFETIME TRADITION. Like your family, the Elkay family has values and traditions that endure. For almost a century, Elkay has been a family-owned and operated company, providing thousands of jobs that support our families and communities.



**PRODUCT COMPLIANCE**

- ADA & ICC A117.1
- ASME A112.19.3/CSA B45.4
- Buy American Act
- NSF/ANSI 61 & 372 (lead free)



Complies with ADA & ICC A117.1 accessibility requirements when installed according to the requirements outlined in these standards. Installation may require additional components and/or construction features to be fully compliant. Consult the local Authority Having Jurisdiction if necessary.

[Installation Instructions \(PDF\) - 97156C](#)

Water Systems are warranted for 12 months from date of installation.  
**Warranty pertains to drinking water applications only. Non-drinking water applications are not covered under warranty.**

[Warranty \(PDF\)](#)

PART: \_\_\_\_\_ QTY: \_\_\_\_\_

PROJECT: \_\_\_\_\_

CONTACT: \_\_\_\_\_





DATE: \_\_\_\_\_

NOTES: \_\_\_\_\_

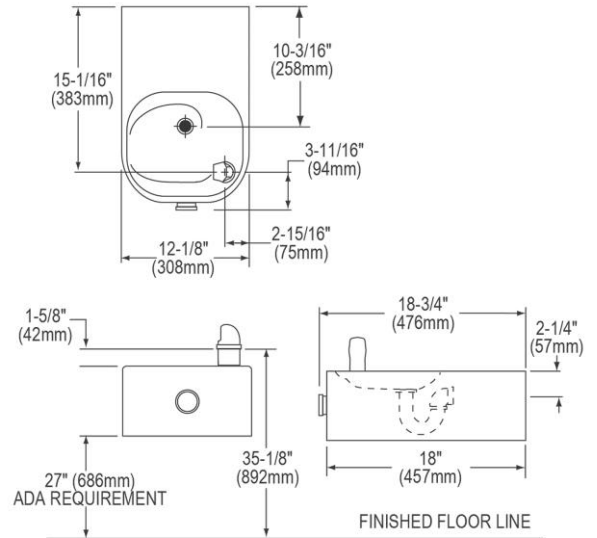
APPROVAL: \_\_\_\_\_

*In keeping with our policy of continuing product improvement, Elkay reserves the right to change product specifications without notice. Please visit [elkay.com](http://elkay.com) for the most current version of Elkay product specification sheets. This specification describes an Elkay product with design, quality, and functional benefits to the user. When making a comparison of other producers' offerings, be certain these features are not overlooked.*



Optional Accessories		
<a href="#">EWF172</a>	Elkay WaterSentry Filter Kit (Coolers + Fountains) <a href="#">Spec Sheet (PDF)</a>	
<a href="#">MPW101</a>	In-wall Mounting Plate for Single-station Non-refrigerated Fountains <a href="#">Spec Sheet (PDF)</a>	
<a href="#">WP2</a>	Wall Plate for EDFP210C and EDFP214C fountains <a href="#">Spec Sheet (PDF)</a>	
<a href="#">AP99</a>	Elkay Access Panel 9" x 9" x 6" <a href="#">Spec Sheet (PDF)</a>	

In keeping with our policy of continuing product improvement, Elkay reserves the right to change product specifications without notice. Please visit [elkay.com](http://elkay.com) for the most current version of Elkay product specification sheets. This specification describes an Elkay product with design, quality, and functional benefits to the user. When making a comparison of other producers' offerings, be certain these features are not overlooked.

**INSTALLER NOTE**

This drinking fountain is furnished with a bubbler and valve including all connecting fittings which are manufactured of completely lead free material. Shut off valve (not furnished) to accept 3/8" O.D. unplated copper tube.

**OPERATION OF QUICK CONNECT FITTINGS**

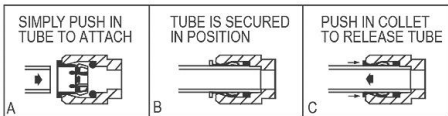

PUSHING TUBE IN BEFORE PULLING IT OUT HELPS TO RELEASE TUBE

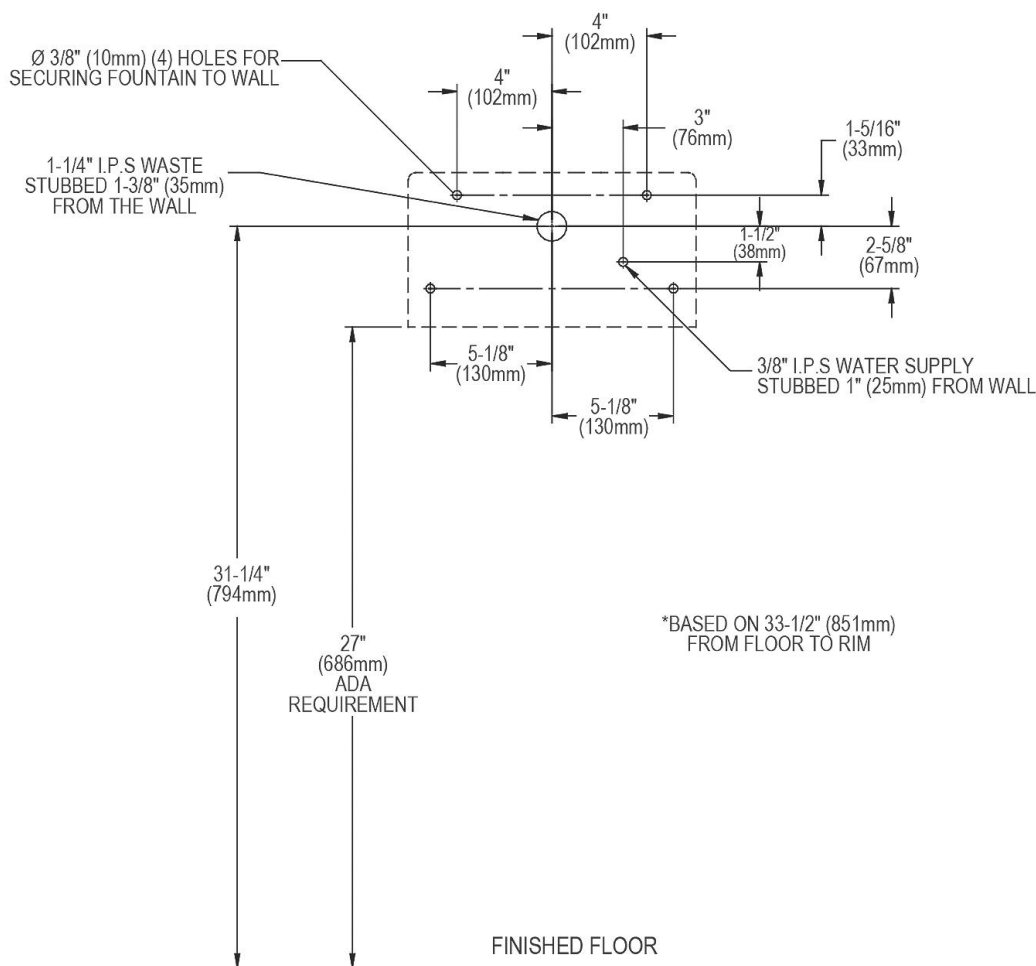
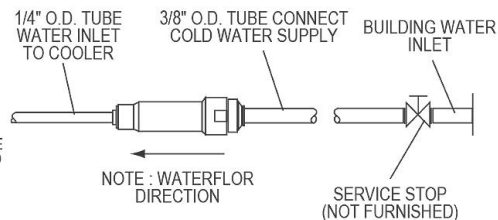

In keeping with our policy of continuing product improvement, Elkay reserves the right to change product specifications without notice. Please visit [elkay.com](http://elkay.com) for the most current version of Elkay product specification sheets. This specification describes an Elkay product with design, quality, and functional benefits to the user. When making a comparison of other producers' offerings, be certain these features are not overlooked.