

ELKAY®

INSTALLATION / OWNER'S MANUAL

Soap Dispenser

Model # LK315

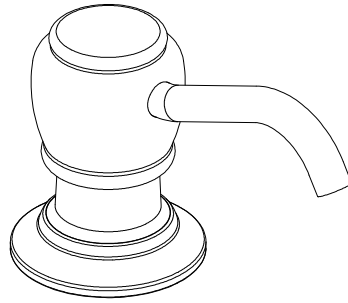

INCLUDES:

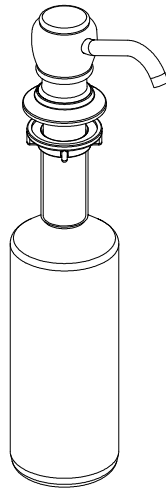

RECOMMENDED TOOLS:

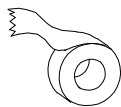

Sealant Tape



Plumber's Putty

SAVE FOR CONSUMER

WARNING: Please carefully read and properly follow the instructions for installation found in this manual.

STEPS:

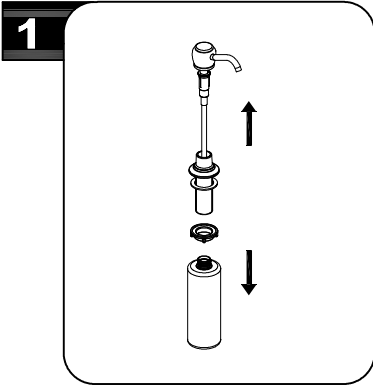

Remove the bottle. Separate soap dispenser head from flange body assembly.

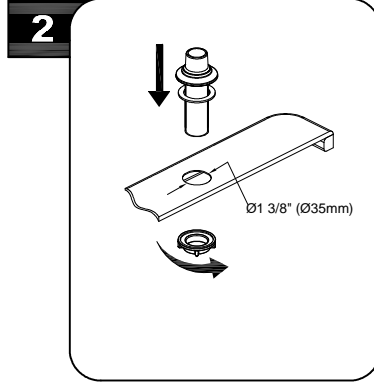

Insert body assembly through selected hole in sink. Secure body to sink by screwing the mounting nut from the underside of the sink. Hand tighten only.

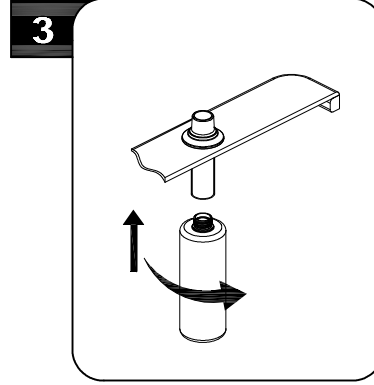

Screw bottle onto body assembly shank.

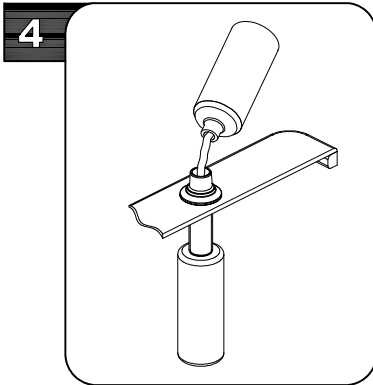

Pour in soap (not included) into the shank orifice.

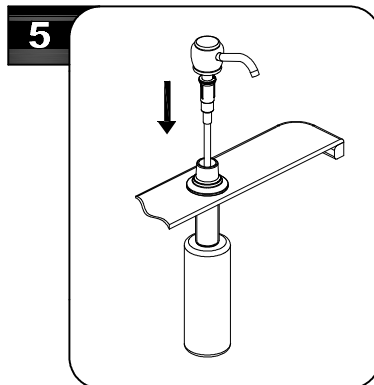

Reinsert soap head into top of the flange.

WARRANTY

ELKAY LIMITED LIFETIME WARRANTY

ELKAY LIMITED LIFETIME WARRANTY

Elkay warrants that all parts and finishes of the Elkay Residential brand faucets are free from defects in materials and workmanship for the life of the product, if purchased after 1996. This warranty covers the original consumer purchaser of the product only.

If the product should leak or drip during normal use, Elkay will provide, free of charge, a replacement cartridge. For other defects in material or workmanship, Elkay will, at its option, supply replacement parts (or if no longer available a comparable product). Elkay reserves the right to examine product in question and its installation prior to replacement.

What is not covered:

1. Damage caused by accident, negligence, misuse, abuse, improper installation or operation or failure to follow care or installation instructions enclosed with your product.
2. Damage occurring during shipment of the product (claims must be presented to the carrier).
3. Normal wear and tear.
4. Labor charges, costs of removal and reinstallation, and any damages to other property.
5. All industrial, commercial and business use whose purchasers are hereby extended a limited lifetime on mechanical parts and 5 years on finish.

What you must do to obtain warranty service:

Either write to Elkay, attention Customer Care, 2222 Camden Court, Oak Brook, IL 60523 or call 1-800-223-5529. Please provide date of purchase and installation, description of nature of the defect, and model number or description of model and/or component part.

THIS LIMITED WARRANTY IS EXPRESSLY IN LIEU OF ANY OTHER WARRANTIES, EXPRESSED IMPLIED, ARISING BY LAW OR OTHERWISE, INCLUDING WITHOUT LIMITATION, ANY IMPLIED WARRANTY OF MERCHANTABILITY OR FITNESS FOR A PARTICULAR PURPOSE. THIS LIMITED WARRANTY MAY NOT BE ALTERED, VARIED, OR EXTENDED, EXCEPT BY A WRITTEN INSTRUMENT EXECUTED BY ELKAY. THE REMEDY OF REPAIR OR REPLACEMENT AS PROVIDED UNDER THIS LIMITED WARRANTY IS EXCLUSIVE. IN NO EVENT SHALL THE MANUFACTURER BE LIABLE FOR ANY CONSEQUENTIAL OR INCIDENTAL DAMAGES TO ANY PERSON, WHETHER OR NOT OCCASIONED BY NEGLIGENCE OF ELKAY, INCLUDING WITHOUT LIMITATION DAMAGES FOR LOSS OF USE, COSTS PROPERTY DAMAGE OR OTHER MONETARY LOSS.

Some states do not allow the exclusion or limitation of incidental or consequential damages or limitations on how long an implied warranty lasts, so the above limitations or exclusions may not apply. This warranty gives you specific legal rights and you may also have other rights which vary from state to state.

This warranty covers product installed in the United States and Canada.

CARE AND CLEANING INSTRUCTIONS

Congratulations on your purchase of an Elkay product. Although your product is extremely durable, attention should be given to the care, cleaning and maintenance of this product. Cleaning agents and abrasives may cause damage, which may result in oxidation and discoloration.

By following these simple guidelines for proper care and cleaning, it will give you years of enjoyment:

TO CLEAN: Simply wipe gently with a damp cloth and blot dry with a soft towel. A common rule of thumb is: when you dry off, dry off your product.

- Avoid build-up of soap, toothpaste or mineral deposits, as these tend to have an adverse effect on the appearance of the product.
- NEVER use cleaning products of any kind on this product - especially those containing ammonia, bleach or alcohol - or those with any form of abrasive.

FOR CARE AND MAINTENANCE:

- The water in certain areas of the world can be very caustic - standing water around the product can cause damage. Be sure to remove standing water with a dry, soft cloth as soon as possible.
- For polished brass finishes, as often as once a week, you can apply a paste wax or special, non-abrasive, brass coating (DO NOT APPLY POLISH).
- Before applying a protective coating, gently brush the entire fixture using a soft tooth brush. This will remove any dirt or deposit build-up.
- These simple steps will add temporary protective coating to your faucet and extend the life of the finish.

Failure to follow care and cleaning will void your warranty. For additional information, please visit elkayusa.com.

Elkay

elkayusa.com

©2011 Elkay
Model # LK315
P99337 (Rev. date: 04/2011)