



Springdale®

Under-mount Bar Sink

11448

Features

- Rectangular bowl.
- No faucet holes; requires wall- or counter-mount faucet.
- Luster bowl finish.
- Includes reveal and no-reveal option.
- SilentShield® sound-absorption technology offers quieter performance.
- 11448 = single pack.
- J11448 = 3 per pack.
- T11448 = 20 per pack.
- 16-1/4" (413 mm) x 17-3/4" (451 mm) x 8" (203 mm)

Material

- 18-gauge stainless steel.

Installation

- Under-mount.

Recommended Accessories

7400 Duostrainer™ Sink Strainer
11862 Sink Rack

Components

Product includes:

91915 Hardware Kit

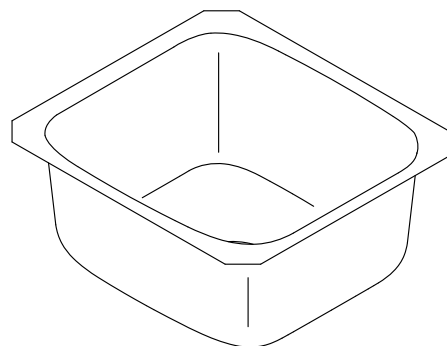

Codes/Standards

ASME A112.19.3/CSA B45.4

STERLING® Warranty - Stainless Steel Sinks

See website for detailed warranty information.

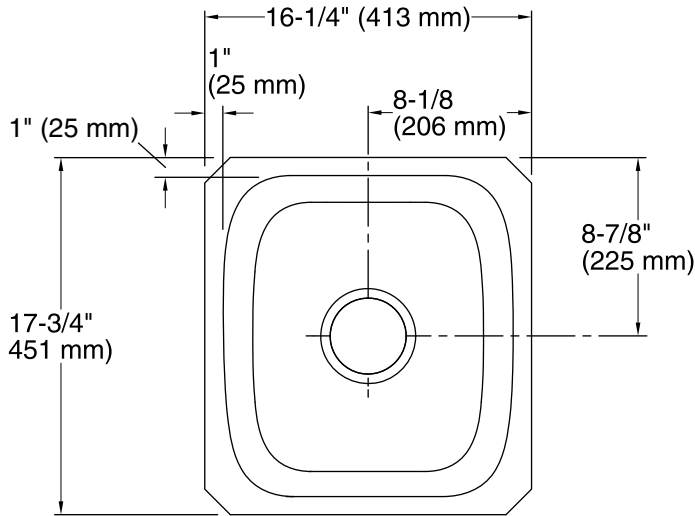

Mounting bracket assembly provides a secure installation.

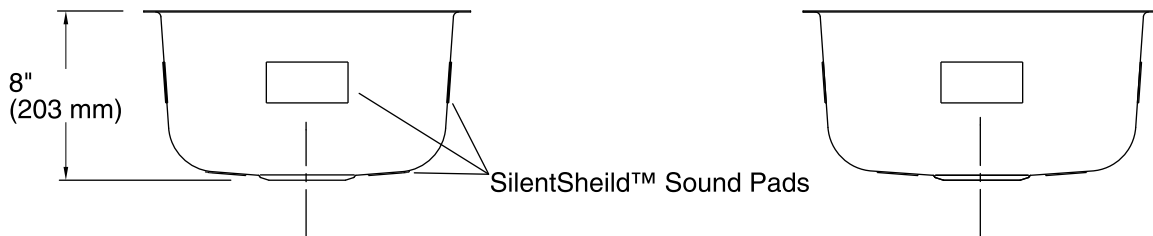
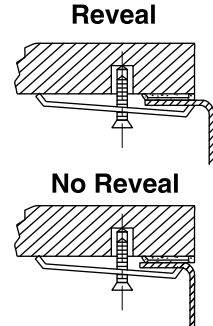

Technical Information

All product dimensions are nominal.

- Bowl configuration: Single
- Installation: Under-mount
- Min. base cabinet width: 21" (533 mm)
- Bowl area (Only)
 - Length: 14-1/4" (362 mm)
 - Width: 15-3/4" (400 mm)
 - Bowl depth: 8" (203 mm)
 - Water depth: 8" (203 mm)
- Drain hole: 3-3/4" (95 mm)
- Template: 1061195-7, required, included

Notes

- Install this product according to the installation instructions.
- Measure your actual product for roughing-in details.
- Use the supplied cut-out template to select either a hidden or exposed rim.