



Middleton®

Top-mount Kitchen Sink

F14711-3

Features

- Top-mount
- Three faucet holes
- 8"-deep single bowl
- 3-5/8" drain opening
- Stainless steel with durable satin finish
- SilentShield technology
- 20-gauge stainless steel
- Lifetime limited warranty

Recommended Products/Accessories

7400 Sink Strainer

Included Components

Product consists of:

1150001 Installation Clips



Codes/Standards

ASME A112.19.3/CSA B45.4

STERLING® Warranty - Stainless Steel Sinks

See website for detailed warranty information.

1-800-STERLING (1-800-783-7546)

Kohler Co. reserves the right to make revisions without notice to product specifications.

For the most current Specification Sheet, go to www.sterlingplumbing.com.

3-17-2019 12:30 - US

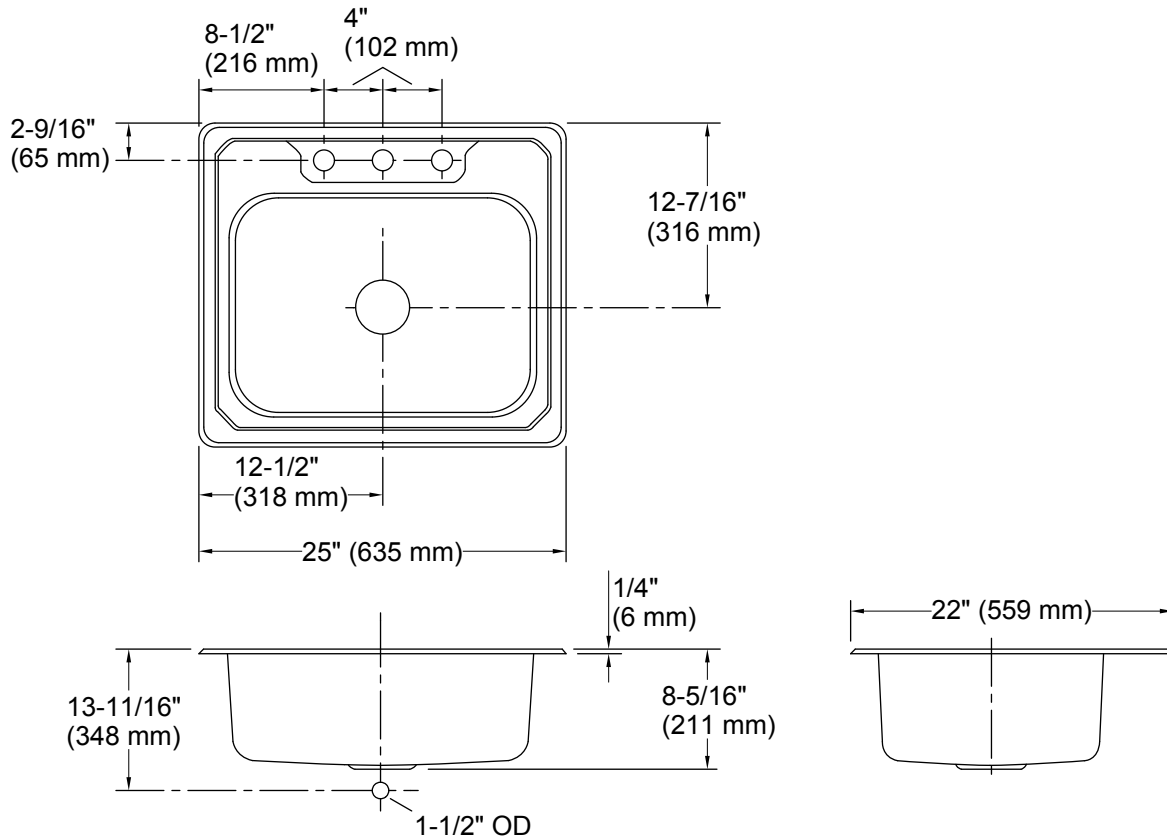

Technical Information

All product dimensions are nominal.

- Bowl configuration: Single
- Installation: Top-mount
- Cutout: Top-mount, 24-1/2" x 21-1/2" (622 mm x 546 mm) with 1/2" (13 mm) radius corners
- Bowl area (Only): Length: 21" (533 mm)
Width: 15-1/4" (387 mm)
Bowl depth: 8" (203 mm)
Water depth: 8" (203 mm)
- Number of deck holes: 3
- Faucet hole(s): 1-7/16" (37 mm)
- Drain hole: 3-5/8" (92 mm)

Notes

- Install this product according to the installation instructions.
- Measure your actual product for roughing-in details.