



Features

- Low-threshold design for easy entry and exit.
- Single threshold for three-wall installation.
- Durable acrylic construction.
- Right drain.
- Integral 18-inch undercut seat at left.
- Coordinates with other products in the Tresham collection.

Recommended Accessories

- K-1733 9 kW Steam Generator
- K-702206-G54 Frameless Sliding Shower Door
- K-702206-G73 Frameless Sliding Shower Door
- K-702206-L Frameless Sliding Shower Door
- K-702207-L Frameless Sliding Shower Door
- K-702217-L Frameless Sliding Shower Door
- K-705705-L Frameless Pivot Shower Door
- K-705711-L Frameless Pivot Shower Door
- K-705717-L Frameless Pivot Shower Door
- K-705723-L Frameless Pivot Shower Door
- K-705729-L Frameless Pivot Shower Door
- K-705741-L Frameless Pivot Shower Door
- K-705810-L Semi-Frameless Pivot Shower Door
- K-705811-L Semi-Frameless Pivot Shower Door
- K-705824-L Semi-Frameless Pivot Shower Door
- K-705825-L Semi-Frameless Pivot Shower Door
- K-706009-D3 Frameless Sliding Shower Door
- K-706009-L Frameless Sliding Shower Door
- K-706012-L Frameless Sliding Shower Door
- K-706013-L Frameless Sliding Shower Door
- K-706015-D3 Frameless Sliding Shower Door
- K-706015-L Frameless Sliding Shower Door
- K-706019-L Frameless Sliding Shower Door
- K-9132 Shower Drain



Codes/Standards







- CSA B45.5/IAPMO Z124
- ASTM E162
- ASTM E662
- Greenguard UL 2818 - Gold

KOHLER® Plastic Baths and Receptors Lifetime Limited Warranty

See website for detailed warranty information.

Available Color/Finishes

Color tiles intended for reference only.

Color	Code	Description
	0	White
	96	Biscuit
	47	Almond
	NY	Dune
	95	Ice™ Grey
	G9	Sandbar

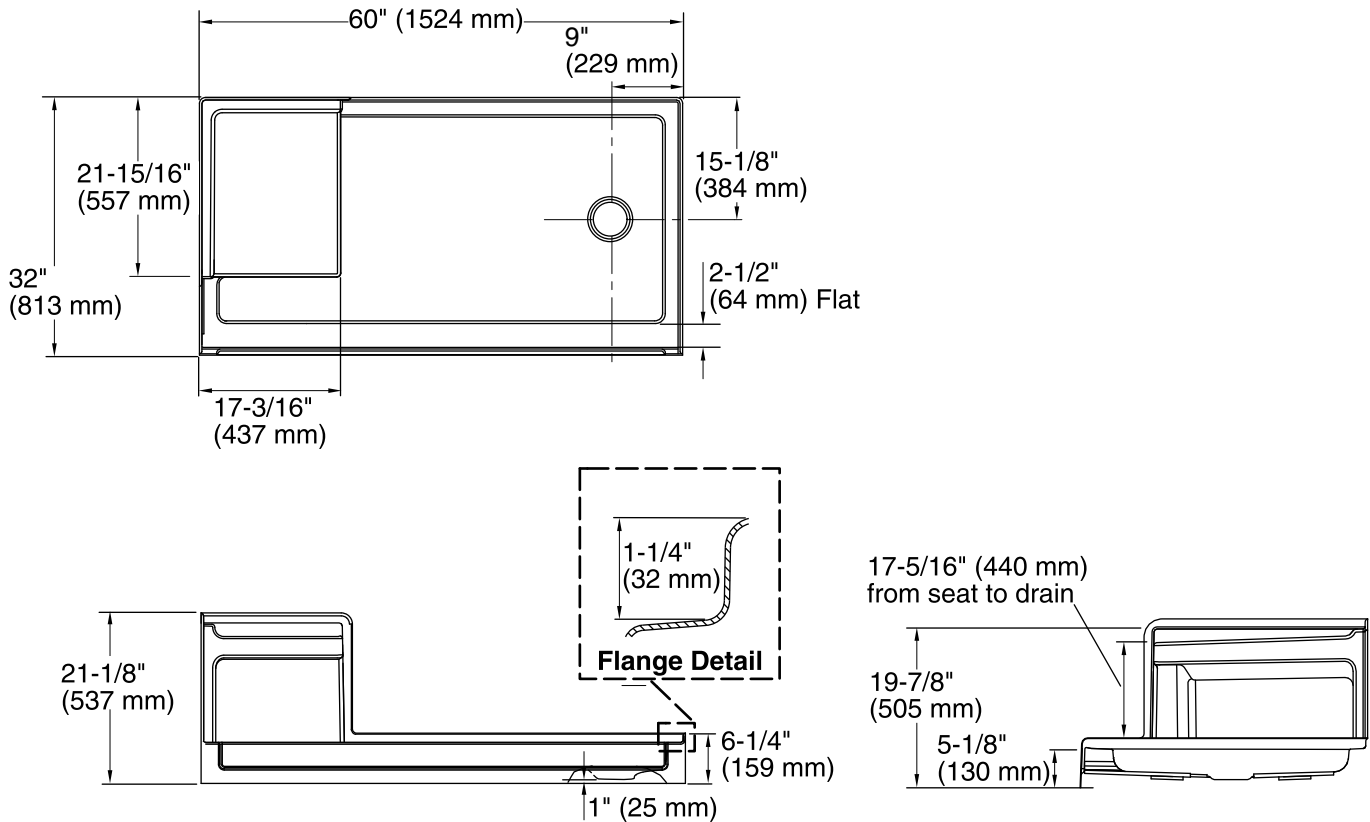

Technical Information

All product dimensions are nominal.

Installation: 3-Wall Alcove
 Drain location: Right
 Weight: 72 lbs (32.7 kg)
 Minimum floor load: 20 lbs/ft² (97.6 kg/m²)

Notes

Measure your actual product for rough-in details. Install this product according to the installation instructions. Shimming may be required between the stud frame and the fixture. Stud opening tolerance is +1/4" (6 mm), -0" (0 mm). KOHLER steam generator/control kit are designed for use with this product. Kohler Co. shall not be responsible for problems encountered due to the installation and use of other manufacturer's steam generators.