

Features

- Two-piece toilet.
- Elongated bowl offers added room and comfort.
- Comfort Height® feature offers chair-height seating that makes sitting down and standing up easier for most adults.
- 1.6 gallons per flush (gpf).
- 2-1/8-inch glazed trapway.
- Standard left-hand trip lever included.
- Combination consists of the K-4380 bowl and the K-4642 tank.
- Coordinates with other products in the Memoirs collection with Stately design.

Technology

- Single-flush gravity uses the force of gravity and a precision-engineered tank, bowl, and trapway to create a strong siphon during flushing.
- AquaPiston canister allows water to flow into the bowl from all sides (360 degrees), increasing the power and effectiveness of the flush.
- Flush valve's 3:2 ratio harnesses the natural force of gravity and optimizes flush performance.
- Durable canister design has 90% less exposed seal material than a 3-inch flapper, for leak-free performance.
- Light-touch canister flush requires a lower actuation force than a flapper.
- AquaPiston canister flush valve optimizes flush performance and resists warping and deterioration.

Installation

- Standard 12-inch rough-in.
- Three-bolt installation.
- Seat and supply line not included.

Recommended Accessories

K-4636 Cachet® Quiet-Close™ Elongated Toilet Seat
K-5588 Purefresh® Elongated Toilet Seat
K-4108 C3®-230 Elongated Cleansing Toilet Seat
K-5420 Low-Profile Bolt Caps
K-9167-L Trip Lever
K-484 Trip Lever
1023457 Wax Ring/Hardware Kit
1265114 Connector Hose

Components

Product includes:

K-4380 Toilet Bowl
K-4642 Toilet Tank

Additional included component/s: Tank cover, Trip lever, Bolt cap accessory pack, and Tank accessory pack.



ADA CSA B651 OBC

Codes/Standards







ASME A112.19.2/CSA B45.1
DOE - Energy Policy Act 1992
California Energy Commission (CEC)
ADA
ICC/ANSI A117.1
CSA B651
OBC

KOHLER® One-Year Limited Warranty

See website for detailed warranty information.

Available Color/Finishes

Color tiles intended for reference only.

Color	Code	Description
	0	White
	96	Biscuit
	47	Almond
	NY	Dune
	95	Ice™ Grey
	G9	Sandbar
	7	Black Black™

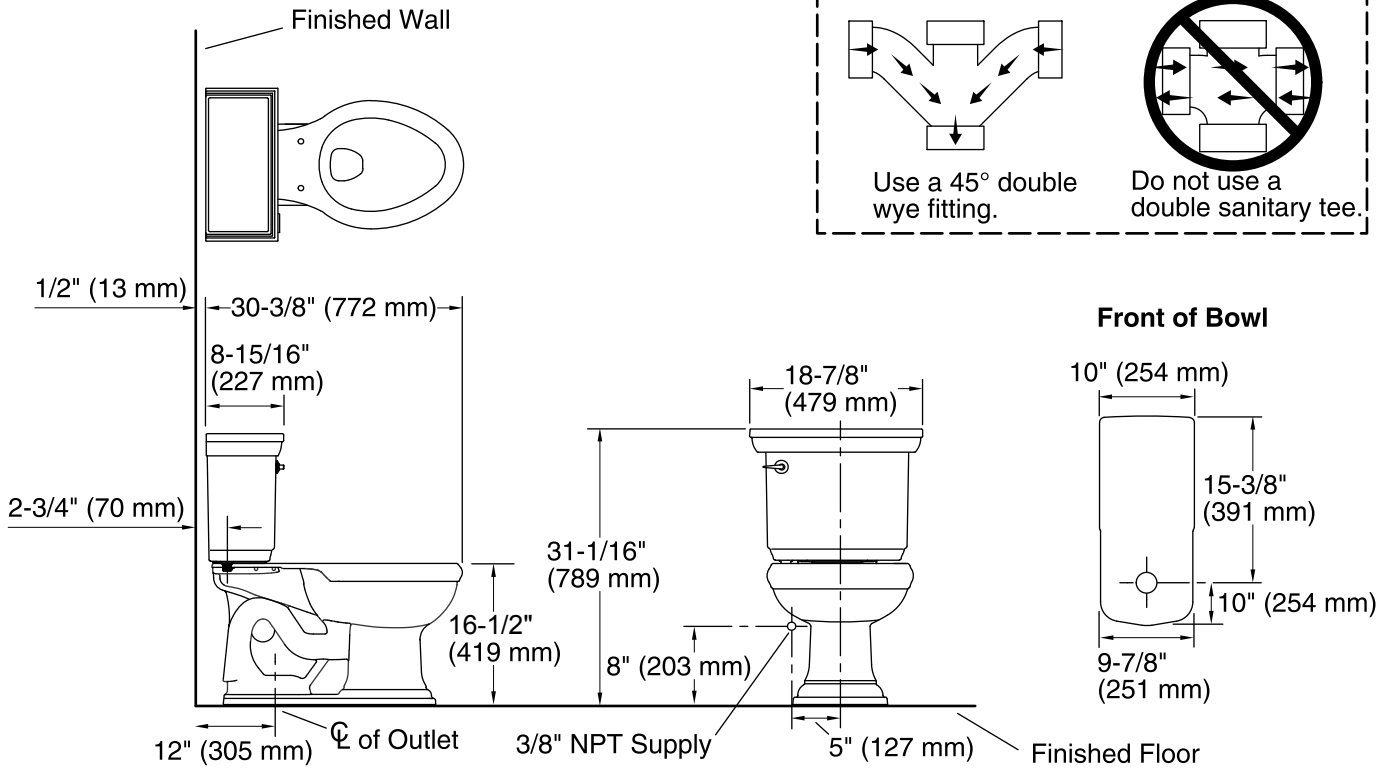

Technical Information

All product dimensions are nominal.

Toilet type:	Two-piece, Floor-mount
Waste Outlet:	Floor
Bowl shape:	Elongated front
Flush type:	AquaPiston®
Trap passageway:	2-1/8" (54 mm)
Water Consumption	
Full:	1.6 gpf (6 lpf)
Water surface size:	11-3/4" x 9-1/2" (298 mm x 241 mm)
Rim to water surface:	5-3/8" (137 mm)
Rough-in:	12
Seat-mounting holes:	5-1/2" (140 mm)

Notes

Install this product according to the installation instructions.

For back-to-back toilet installations: Use only a 45° double wye fitting.

ADA, OBC, CSA B651 compliant when installed to the specific requirements of these regulations.

Plumbing codes may require elongated toilets and elongated, open-front seats in public bathrooms.

Accessibility standards may require controls to be located on the open side of the toilet.