



Brevia™ Quick-Release™

Round-Front Toilet Seat

K-4775

Features

- Quick-Release™ hinges allow seat to be unlatched from toilet for easy removal and convenient cleaning; no tools required.
- Quick-Attach® hardware for fast and secure installation.
- Color-matched plastic hinges.

Material

- Plastic



Codes/Standards







IAPMO/ANSI Z124.5

KOHLER® One-Year Limited Warranty

See website for detailed warranty information.

Available Color/Finishes

Color tiles intended for reference only.

Color	Code	Description
	0	White
	96	Biscuit
	47	Almond
	NY	Dune
	95	Ice™ Grey
	G9	Sandbar
	7	Black Black™

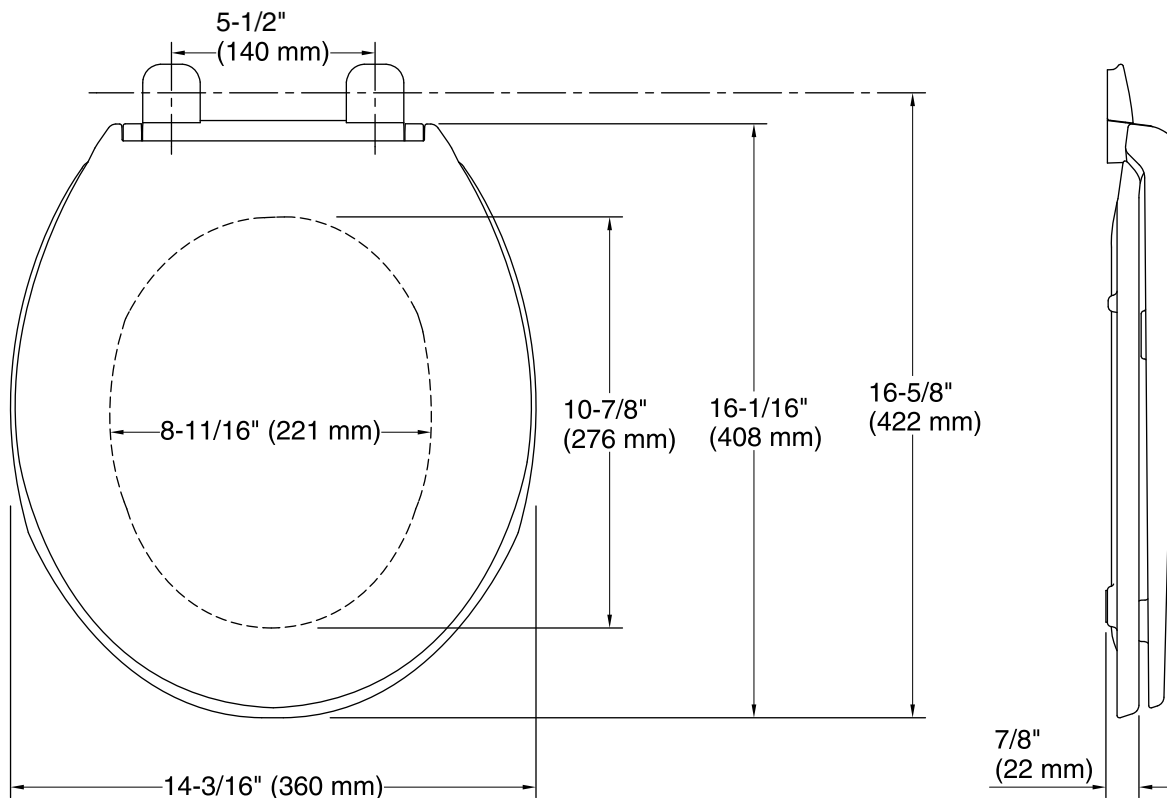

Technical Information

All product dimensions are nominal.

Seat shape type: Round-front

Seat front type: Closed-front

Seat-mounting holes: 5-1/2" (140 mm)

Notes

Install this product according to the installation guide.