

**Features**

- 34½" (876) x 20½" (521) x 11" (279) undermount kitchen sink.
- Large offset single compartment.
- Handcrafted from 14 gauge 304 stainless steel. Channel grooves in sink bottom direct water to drain. Premium brushed finish.
- Beveled ledge around the top edge of the sink. The ledge allows cutting board, colander and other accessories to easily glide across the length of the sink.
- Accessory Pocket in apron front is hidden from view and makes great storage for sponges, brushes and other kitchen tools used daily.
- Includes a stainless steel bottom sink grid and stainless covered flip-top sink strainer.
- Tight 5mm radius corners.
- Superior 7mm sound deadening pads.
- Fits 36" (914) minimum base cabinet width.

**Components**

- Product includes:
- TSGP34181 Bottom Sink Grid
  - 2210R Covered Sink Strainer
  - Cutout Template
  - Installation Hardware
  - Installation Instructions

**Warranty**

- Lifetime Limited Warranty

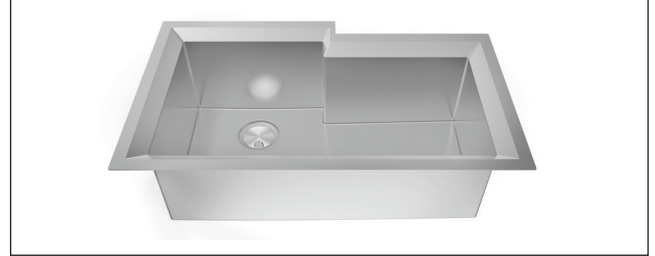

**Specified Model**

Model	PUSSO352111
Overall Dimensions	L34½" x W20½" x D11" 876 x 521 x 279
Bowl Dimensions (Left Side)	L14¾" x W15¾" x D11" 375 x 400 x 279
Bowl Dimensions (Right Side)	L14¾" x W13⅝" x D11" 375 x 338 x 279
Drain hole:	3⅝" (92mm)
Shipping Weight	56 lbs.
Material	14 gauge 304 stainless steel
Installation	under counter mounted
Required	template, included

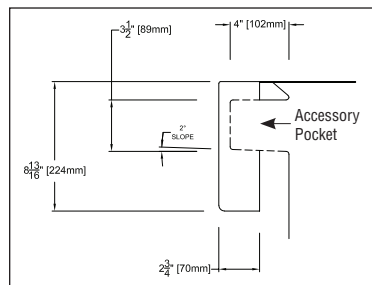
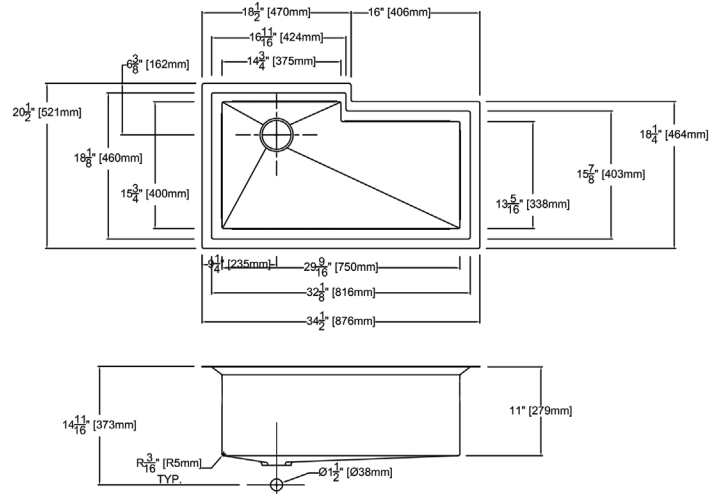

Accessory Pocket Detail

**Codes/Standards**

ASME A112.19.3/CSA B45.4

**Notes**

Install this product according to the installation instructions.

**Components**

Product includes:

TSGP34181 Bottom Sink Grid

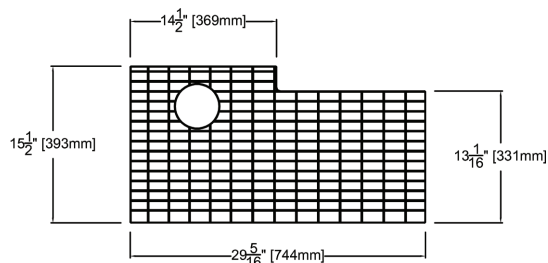

2210R Covered Flip Top Sink Strainer.

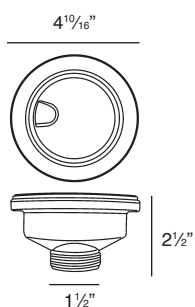

Water drains easily when cover is in place. Cover flips up with easy touch. Polypropylene housing. Fits standard 3½" opening.

**Optional Accessories**

2310 Remote Covered Flip Top Sink Strainer.

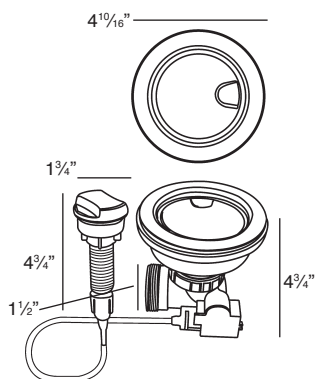

Turn the remote knob to open and close drain. Water drains easily when cover is in place. Cover flips up with easy touch. Polypropylene housing. Fits standard 3½" opening. 1⅜" hole required in countertop for remote installation. Remote cable 25½" L.

4010 Covered Flip Top Disposer Strainer.

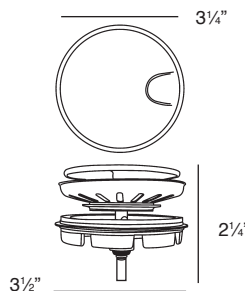

Water drains easily when cover is in place. Cover flips up with easy touch. Polypropylene housing. Top mount installation for 3½" opening.