

FEATURES

- Décor features the look and soft feel of solid surface. The 1/8" layer of solid surface provides beauty and easy clean design.
- Vanity tops in standard sizes with modified ogee front edge.
- Depth: 22 1/4"
- Integral solid surface 17"x12" oval bowl in same color as vanity deck.
- Thickness: 1 1/4"
- 4" high x 1/2" deep integral covered backsplash with eased edge profile.
- Single, 4" or 8" faucet hole drillings
- Single and Double bowls.
- 5 Year Ltd. Residential Warranty
1 Year Ltd. Commercial Warranty

COLORS

- 12 Décor colors

OPTIONS

- Side Splashes with eased edge profile. See note below

Backsplash

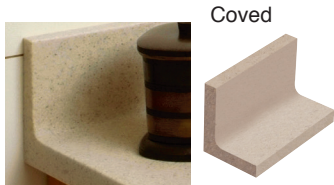

Covered

Front Edge Profile

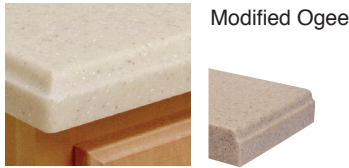

Modified Ogee

To Be Specified: Faucet Hole Drilling

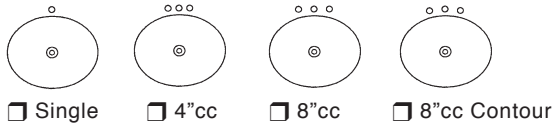

Single 4''cc 8''cc 8''cc Contour

To Be Specified: Vanity Top Color

DÉCOR Colors



White A5

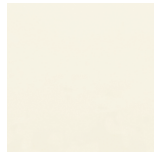

Cameo A6

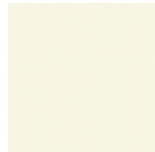

Biscuit A7

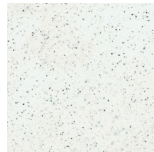

Matrix White A8



Desert Earth A0



Seaside A2



Peppered Sage A3



Sand Castle A4



Matrix Dusk B0



Matrix Khaki B1

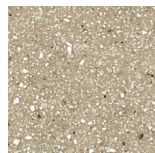

Matrix Sand B2



Matrix Summit B9



Matrix Dusk Décor vanity top with modified ogee edge

To Be Specified: Vanity Top Size

		22-1/4" Depth		
Bowl	Length (A)		Model No.	Ship Wt.
Single	25"	<input type="checkbox"/>	ITBC2522	44 lbs.
Single	31"	<input type="checkbox"/>	ITBC3122	54 lbs.
Single	37"	<input type="checkbox"/>	ITBC3722	65 lbs.
Single	49"	<input type="checkbox"/>	ITBC4922	86 lbs.
Single	61"	<input type="checkbox"/>	ITBC6122	107 lbs.
Double	61"	<input type="checkbox"/>	ITBC61222*	117 lbs.
Sidesplash LH		<input type="checkbox"/>	SSLC22	10 lbs.
Sidesplash RH		<input type="checkbox"/>	SSRC22	10 lbs.

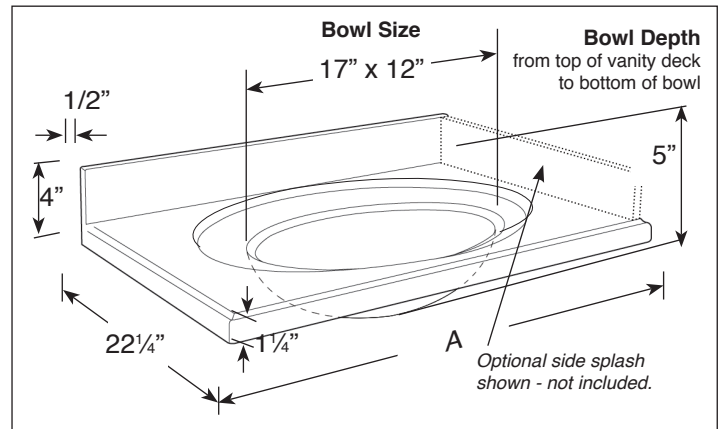

- Side Splashes with eased edge profile. 4" high x 1/2" deep loose side splash is set on after backsplash is installed and butts up to backsplash. Side splash length stops at front edge where profile begins.

*Bowl Center: 61" double bowls 15-1/2" L/R